

**BERA WaterUps**<sup>®</sup>

**Assembly Guide**

**WaterUps**<sup>®</sup> 1680 Wicking Kit

# Contents

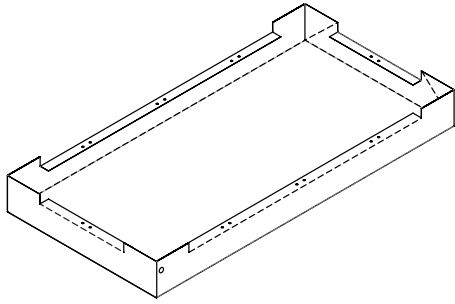

1 x WaterUps® 1680 Reservoir Liner

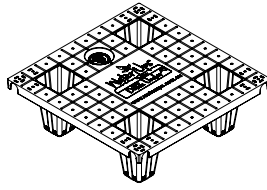

8 x WaterUps® Wicking Cell



1 x Inlet Pipe and cap

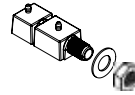

1 x Overflow Pipe



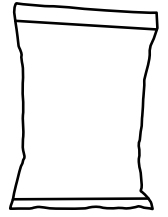

11 x Joiners





1 x 20L bag of Perlite

## You will need

 Approximately 3 square metres of level ground to build on.

 A sharp knife.

 Approximately 500ml of water.

 16 x 25 litre bags of good quality soil or potting mix.

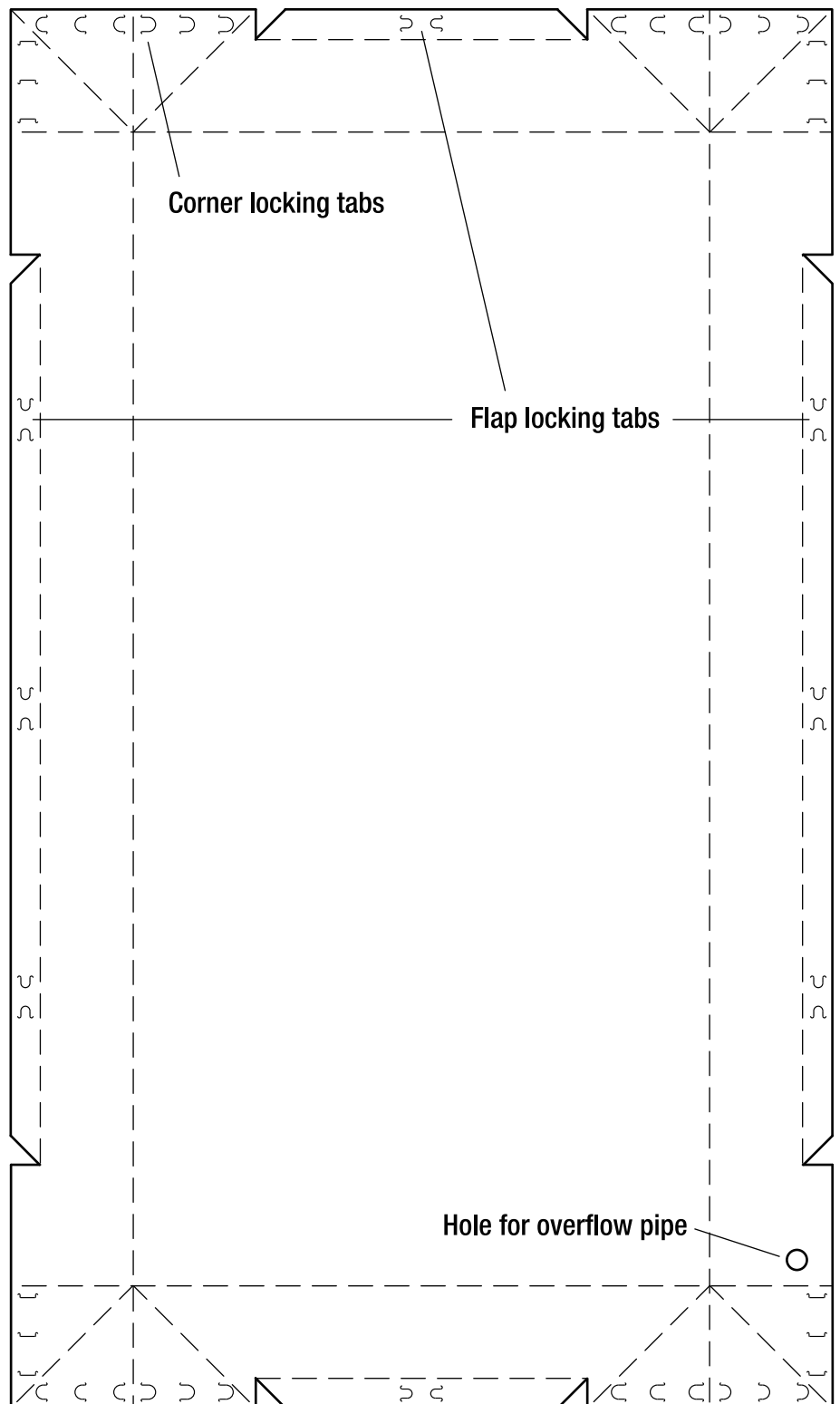

## 1. Preparing the reservoir liner.

Take the liner and completely unfold it, and lay it flat on the ground as shown in the diagram on page 2.

Next, take the corners and fold them back in on themselves, ensuring that the crease is tight, and goes right to the corner, making it nice and square.

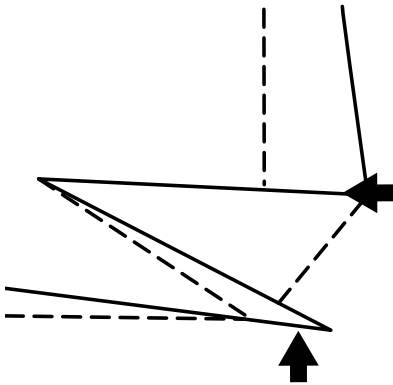
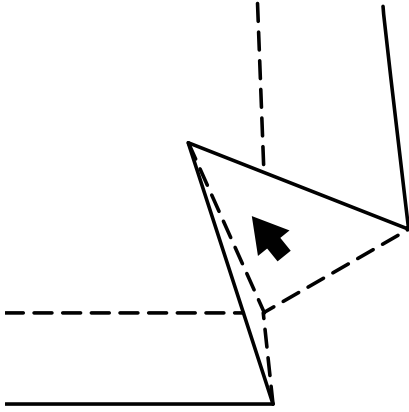

To secure the corners push the three locking tabs through the first two layers of the reservoir liner.

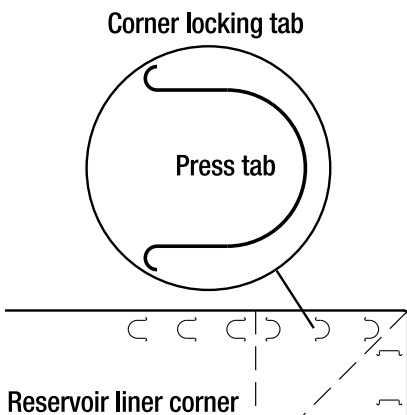

Lock the tabs into the slots in the last layer of the folded liner to secure the corners in place.

Corner locking slot

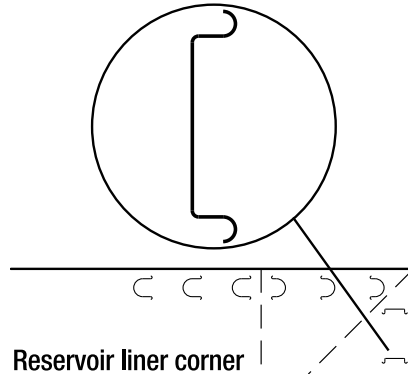

## 2. Creating your wicking bed.

Place the WaterUps® reservoir liner in the bed you have created, making sure that the hole in the liner for the overflow pipe lines up with the hole in the bed walls.

Take one of the WaterUps® Cells and fit the overflow pipe as shown in the image below.

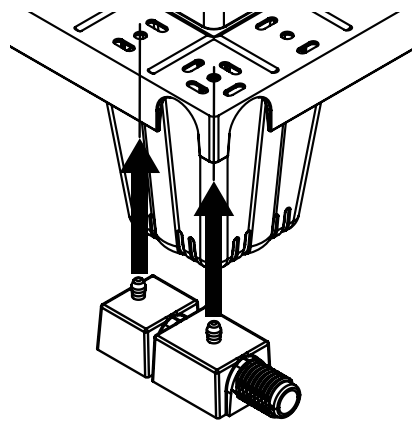

Place the cell in the bed and feed the overflow pipe through the hole in the reservoir liner and the bed wall. Make sure that the cell sits flat on the bottom of the reservoir liner.

Replace the washer on the overflow pipe and tighten the nut.

Place the next seven WaterUps® Cells into the reservoir liners, again making sure that they sit flat on the bottom.

## 3. Fitting the water inlet pipe.

The next step is to fit the water inlet pipe, but first we have to cut a hole in the top of the last remaining WaterUps® Cell to let the water into the reservoir we are creating.

Using a sharp knife cut along the circular groove around the type on the top of the WaterUps® Cell as shown in the image below.

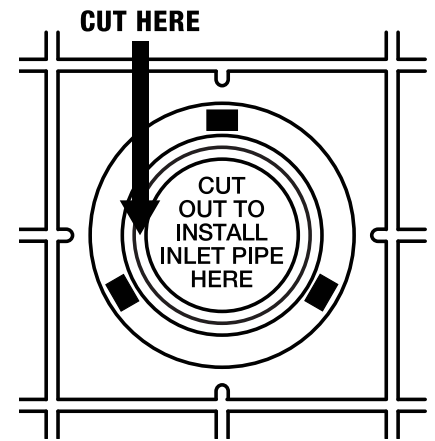

The three tabs on the bottom of the water inlet pipe must lock into the three holes in the tops of the WaterUps® Cell. Apply some pressure to the inlet pipe as you insert it, until it clicks into place in the WaterUps® Cell.

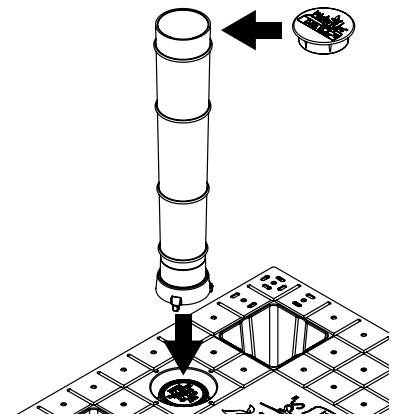

Once the inlet pipe is fitted, place the cell into the last remaining spot in the reservoir liner.

## 4. Fitting the Joiners.

Use the WaterUps® joiners to lock each of the WaterUps® Cells together and to secure the folded flaps of the reservoir liner.

Use the following steps to use the joiners to secure the folded flaps of the reservoir liner to the top of the WaterUps® Cells.

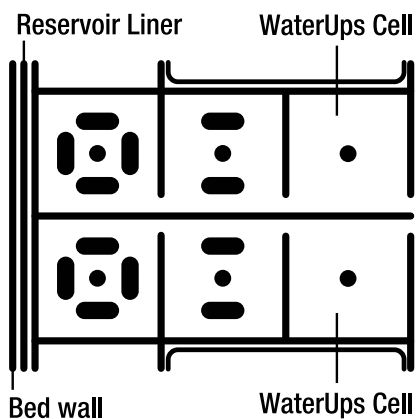

Fold the reservoir liner flap down over the WaterUps® Cells and fold the flap locking tabs back under the reservoir liner to expose the Joiner locking holes in the WaterUps® Cells.

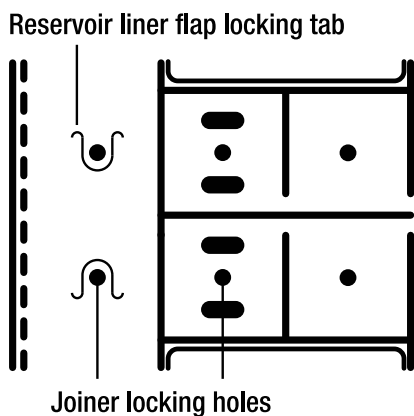

Click the WaterUps® Joiner into the locking holes on the WaterUps® Cells to secure the reservoir liner.

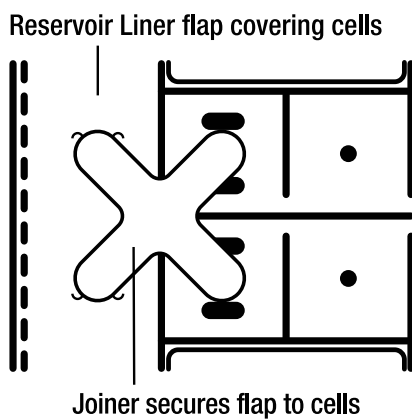

## 5. Adding perlite to the feet of the WaterUps® Cells.

Open the 20 litre bag of perlite and sprinkle some water over the perlite granules to help stop them from blowing away. Distribute the perlite evenly into all four feet of each of the 8 WaterUps® Cells.

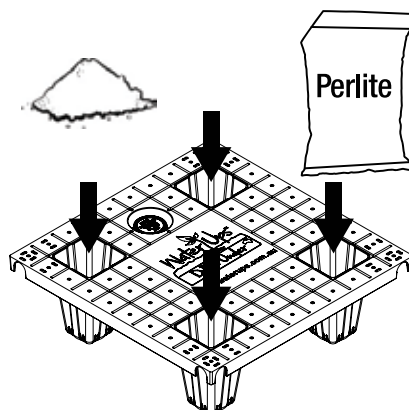

## 6. Watering your WaterUps® wicking bed.

To water your wicking bed simply insert a garden hose into the inlet pipe and fill the water reservoir until water starts flowing out of the overflow pipe. Replace the cap when done.

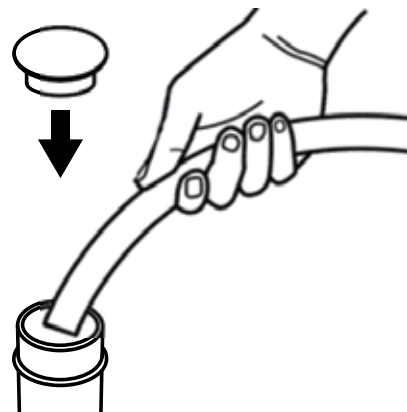

The water reservoir of your wicking bed will hold 140.8 litres of water. How often you need to refill the reservoir will depend on what plants you are growing, the time of year, and the amount of natural rainfall that you receive.

However, in our experience, periods of up to four weeks are achievable before you will need to refill your planter.

It is recommended that you allow the water level in the wicking bed to go down to at least 1/4 full before refilling. This will assist soil aeration.

To check how much water is in the reservoir simply use a dipstick or set up a moisture sensor system.

# Contact us

## HEADQUARTER

**BERA B.V. (THE NETHERLANDS)**

T: +31 (0) 33 257 0302

E: [info@bera-bv.com](mailto:info@bera-bv.com)

## SALES OFFICES

### Belgium

T: +32 474 980 273

E: [raphael@bera-bv.com](mailto:raphael@bera-bv.com)

### Czech Republic

T: +420 777 484 937

E: [beracz@bera-bv.com](mailto:beracz@bera-bv.com)

### France

T: +33 (0) 9 81 12 76 58

E: [info@bera-sarl.fr](mailto:info@bera-sarl.fr)

### Germany

T: +49 (0) 30 78 71 68 85

E: [kontakt@bera-bv.com](mailto:kontakt@bera-bv.com)

### Slovakia

T: +421 910 705 706

E: [slovakia@bera-bv.com](mailto:slovakia@bera-bv.com)

### Centro América

T: +(506) 87039731

E: [centro.america@bera-bv.com](mailto:centro.america@bera-bv.com)

### South Africa

T: +27 83 449 3954

E: [franko@bera-bv.com](mailto:franko@bera-bv.com)

